



Equipment

- RS232 interface and RS485 interface
- CANopen or Profibus DP
- 10 digital inputs (8 programmable)
- 3 digital outputs (2 programmable)
- Clock/direction interface
- 2 Encoder inputs (incremental)
- Optically decoupled encoder output



→ **DC Supply**

Power supply	V _{DC}	24 ... 170
Recommended fuse for power supply	A	10 (slow)
Logic supply	V _{DC}	24 (18-30)
Recommended fuse for logic supply	A	3 (slow)

→ **Data of Power Output Stage**

Maximum effective current per phase	A _{RMS}	8.5
Maximum phase current	A _{DC}	12
Rated output current	A _{RMS}	7
Maximum output voltage	V _{DC}	170
Rated output voltage	V _{DC}	150
Minimum inductivity of motor winding	mH	0.5
Maximum length of motor cable	m	10
Frequency of output current ripple	kHz	16.4

→ **Data of Brake Control**

Output voltage (depending on logic supply)	V _{DC}	24
Output voltage reduced	V _{DC}	12
Output current 100 ms / permanent	A	0.8 / 0.5

Functions

- Operation of 2-phase brushless synchronous motors
- Operation of 2-phase synchronous linear motors (ECOLIN® 200)
- Operation of brushed DC servo motors
- Operation of stepper motors
- Torque, force, speed, and positioning control
- Interpolation via CANopen

→ **Control Signals**

Digital inputs	V	24
	mA	2
Digital outputs	V	24
	A	0.5
Analogue input	- 10 V to + 10 V	
	10 bit resolution	
Analogue monitor outputs	0 ... 5 V	
	8 bit resolution	

→ **Dimensions and Weights**

Dimensions W x H x D	mm	62 x 240 x 170 (without mating connector)
Weight	kg	1.8
Housing	Aluminium, passivated, in conformance with RoHS	
Cable clamping and strain relief	metal clamps, max. cable diameter 15 mm	

→ **Ambient Conditions**

Class	3K3 acc. to EN 50178	
Ambient temperature during operation with rated load	5 ... 40 °C	
Storage temperature	- 10 ... 70 °C	
Degree of humidity (non-condensing)	max. 95% of rel. humidity	
Cooling	mounting on supporting plate	
Installation altitude	max. 1500 m above mean sea level without power reduction	
Mounting position	The technical data refer to a vertical mounting position	
Protection class	IP20, pollution degree 2	
Applied standards for CE	EMC acc. to EN61800-3, safety acc. to EN61800-5-1	
Applied standards for UL	UL508C	



Basic Functions

- Digital speed and position control with position, speed, and torque limiting
- Digital filter functions effective on resonant loads
- Parameterisable velocity profiles with jerk limiting
- Short circuit, voltage, temperature, encoder, tracking error and I²t monitoring
- Parameterisation via RS232, RS485, CANopen, or Profibus DP
- Scalable analogue input for any setpoint
- Scalable analogue monitors for any actual value
- Intelligent control of a holding brake with automatic voltage reduction
- Limit switch and reference sensor evaluation, various reference point approach modes
- Enabling of output stage and reset of fault conditions via digital inputs
- Readiness for operation message via digital output
- Setting of field bus node address via DIP switch
- Status indication via 4 LEDs

Positioning Control on Field Bus

- Setpoint setting via RS232, RS485, CANopen, or Profibus DP
- Point-to-point control
- Path interpolation via CANopen

Master / Slave Positioning

- Parameterisable electric gearbox
- Master position via encoder signals or CANopen

Positioning with Clock / Direction Setpoint

- Scalable setpoint setting via RS422 for clock / direction signals

Positioning with Digital I/O Interface

- 256 motion profiles storable
- 8 digital inputs
- 2 digital outputs
- Event-based control concept

Joystick Operation

- Parameterisable joystick table for speed or position with 256 entries
- Joystick connection to +/-10 V analogue input

Speed Setting with Analogue Setpoint

- Scalable speed setpoint via +/-10 V analogue input
- 10 bit resolution

Mechanical Outlines

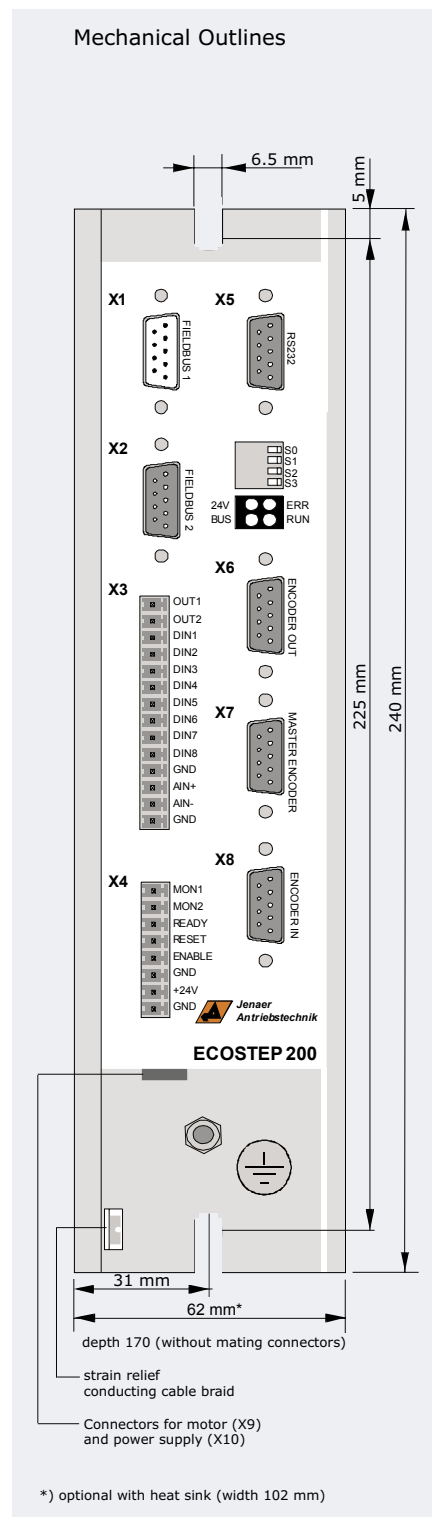

Connections

- Output 1
- Output 2
- Input 1
- Input 2
- Input 3
- Input 4
- Input 5
- Limit switch pos.
- Limit switch neg.
- Home switch
- Signal ground
- Analog input +
- Analog input -
- Signal ground

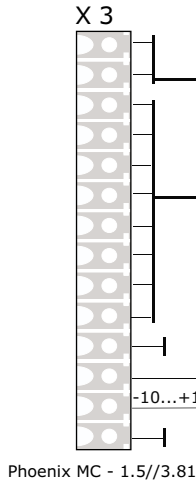
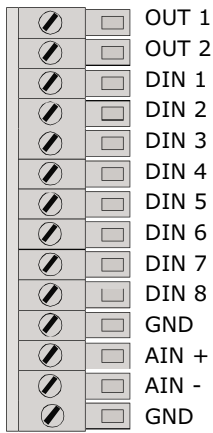

- digital I/O PLC interface
- running configurable motion profiles
- controlling/monitoring of motion ranges / profiles, homing

analog command input for position and velocity
10 bit resolution

- Monitor 1
- Monitor 2
- Ready
- Error reset
- Enable powerstage
- Signal ground
- Supply +24 V
- Supply ground

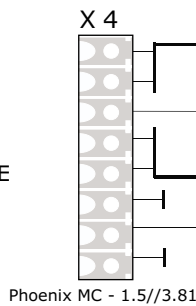
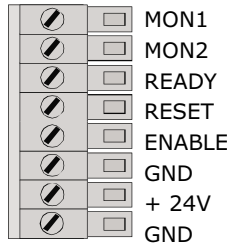

2 analog monitors
scalable, configurable
8 bit resolution

digital output: ready

- digital inputs:
- powerstage enable
 - error reset

monitoring supply voltage,
reset logic

- Brake +
- Brake -
- Motor phase A
- Motor phase /A
- Motor phase B
- Motor phase /B

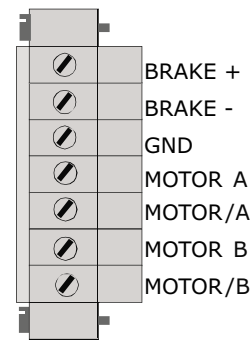

ECO200: Phoenix IC -2.5//5.08
ECO216: Phoenix PC 4/7-G-7.62

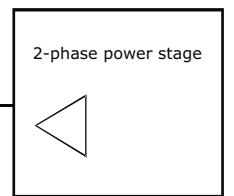
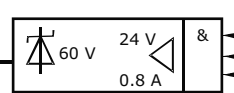
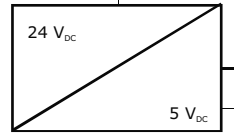

intelligent brake control providing
automatic voltage reduction

control of the powerstage
enable
monitoring:
• short circuit
• overvoltage and undervoltage
• overtemperature power stage

- DC bus ground
- DC bus +

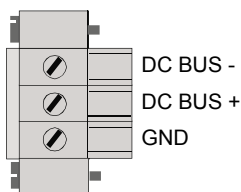

ECO200: Phoenix MSTB -2.5//5.08
ECO216: Phoenix PC 4/3-G-7.62

24.. 170 V_{DC}

galvanic insulation

Interfaces

RS232 serial interface for parameter setting, configuration, control, interface for setup by a PC

Field bus interface CANopen (DS 402)

Field bus interface: RS 485 (published protocols) or Profibus DP

ID setting for serial network operation

4 LEDs for indication of device status

quadrature encoder input: configurable electronic gear box functions or clock/direction

quadrature encoder input: for commutation, current, speed and position control

RS232

1:1 direct connection to a PC COM

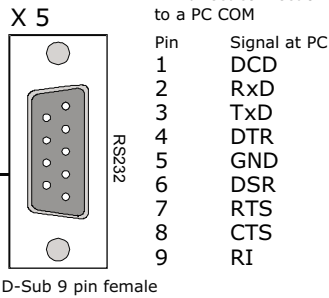

CAN

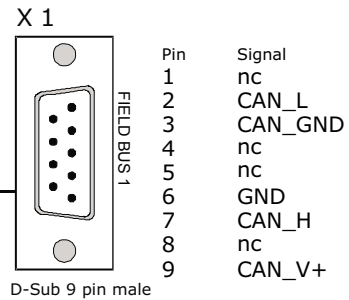

RS485

Profibus DP

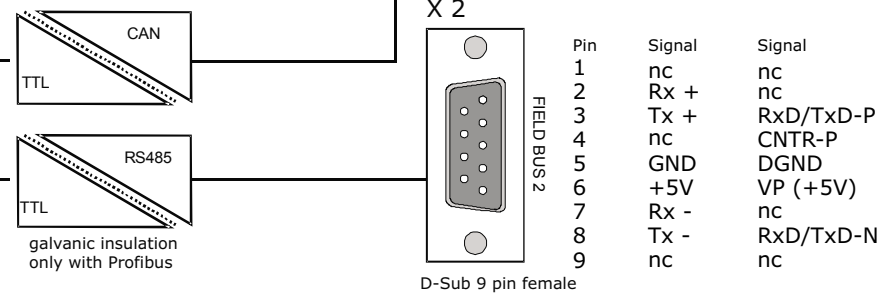

Code switch for network ID
0...15

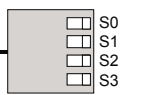

Status LED

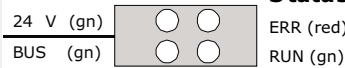

Input Master Encoder

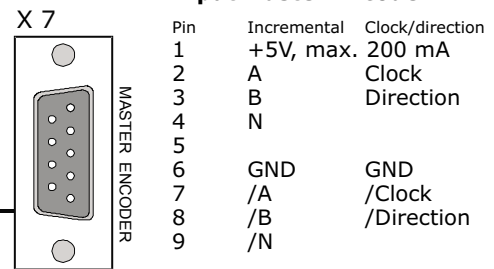

Output Motor Encoder

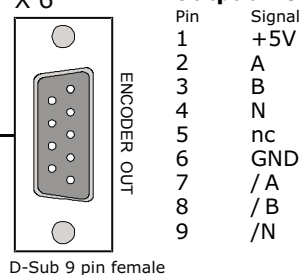

Input Motor Encoder

